

medifa

Member of REINSBERG® GROUP



medifa 5000

Mobile
Operating Tables

Made in Germany

Advantages at a glance

- Manual and electric models
- Versions with low basic height (600 mm)
- Models with sliding table top
- Available with viscoelastic foam SF or PUR upholsteries
- All metal components made of high-quality stainless steel (1.4301)
- Optimal cleaning and disinfection conditions
- Simple movement of the table by means of castors with direction stability
- Smooth running release mechanisms
- User-friendly control concept
- Suitable for various applications and patient positionings
- Suitable for x-ray and c-arm applications
- Wide range of accessories for all surgical disciplines
- Maximum permissible overall load up to 250 kg (550 lbs)



Manual models

Electric models

Functionality and ergonomics

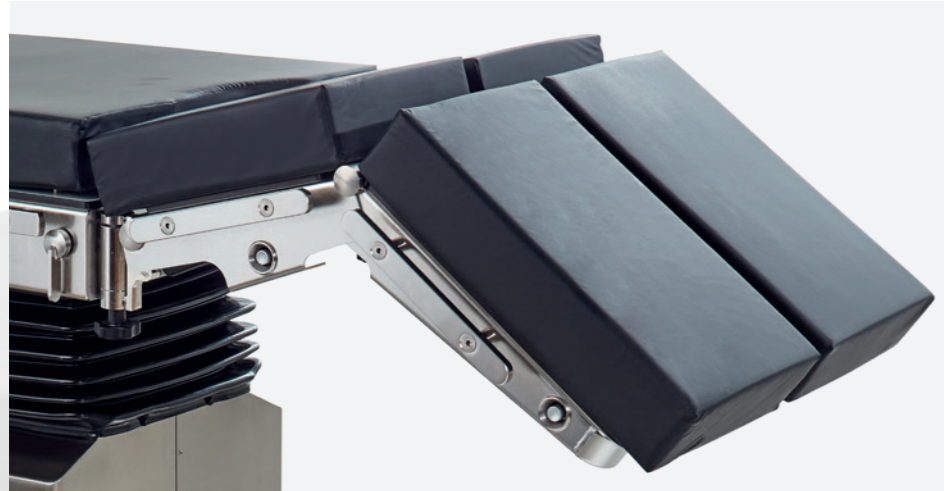

Quick and simple handling

- Smooth running of release mechanisms



Low base height

- Special models with low base height of 600 mm are ideal for applications in a sitting position



Ergonomics

- Easy movement of operating table due to double swivel castors
- Two front castors with direction stability, lockable via foot pedal
- With central brake



Kidney elevator

- All medifa 5000 models can be optionally equipped with a manual kidney elevator

Functionality and comfort



One fixing system for all upholstery parts

- Fixing and removing of upholstery parts by means of pin system
- Particularly hygienic and easy to clean (no Velcro fastenings)
- Easy switching between SF and PUR upholstery

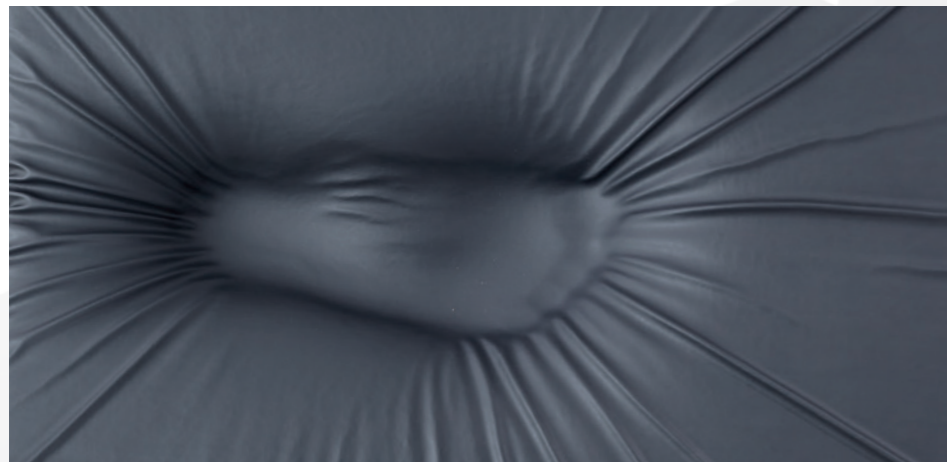

Comfort and hygiene

- Soft and hygienic upholstery prevents nosocomial infections and improves patient safety



SF-Upholstery

- Very soft pressure-relieving viscoelastic foam
- Decubitus prophylaxis
- Height: 80 mm
- Detachable
- Electrically conductive
- Radiolucent



PUR-Upholstery

- Ergonomically formed
- Height: 60 mm
- Detachable
- Electrically conductive
- Radiolucent

Control concept



- Colour display with battery indicator
- Activation of up to three user-defined operating positions (Memory)
- Saving of up to three user-defined operating positions (Memory)
- Reverse-Mode
- Positioning keys
- Stop key
- Activation of hand switch
- Automatic leveling

1. Standard: Backlit hand switch with integrated colour display and battery indicator
2. Standard: Additional control unit at column
3. Optional: Wireless infrared remote control with integrated colour display and battery indicator (art.-no. 604070, not retrofittable)
4. Optional: Foot switch for height, lateral and Trendelenburg adjustment (art.-no. 604060)



medifa 5000 manual



Manual operating table

Art.-no. 501130

- Height adjustment by foot operated hydraulic pump from 750 mm up to 1,000 mm
- Gas spring supported Trendelenburg adjustment from -30° up to +30°
- Lateral tilt by hand crank up to 20°, hand crank insertable at both sides
- Gas spring supported adjustment of back rest from -40° up to +70°
- Adjustment to flex / reflex position
- Continuous X-ray cassette tunnel from head to foot end
- Lateral guide rails for attachment of accessories, stainless steel, 25 x 10 mm
- Viscoelastic SF (H = 80 mm) or PUR upholstery (H = 60 mm), electrically conductive, detachable, radiolucent
- Four double swivel castors \varnothing 125 mm with central brake, electrically conductive, two castors with direction stability
- Maximum permissible overall load up to 200 kg (440 lbs)

Further manual models:

Art.-no. 501135

Additionally with longitudinal sliding up to 310 mm

Configuration example

Art.-no. 501130

Manual operating table

Art.-no. 61144SF

Head rest

Art.-no. 61655SF

Kidney elevator

Art.-no. 61615SF

Divided leg rests

Art.-no. 61220SF

Arm rest

Price on request!

Specialities

- Day surgery
- General surgery
- Gynaecology
- Urology
- Proctology

All models of medifa 5000 can be equipped with a wide range of further accessories!

medifa 5000 electric



Electric operating table

Art.-no 504320

- Electrical height adjustment from 780 up to 1,080 mm
- Electrical Trendelenburg adjustment from -30° up to +25°
- Electrical lateral tilt up to 20°
- Electrical adjustment of back rest from -40° up to +70°
- Adjustment to flex/ reflex position
- Return to 0-position
- Corded hand switch with integrated colour display and battery indicator for electrical functions
- Additional control unit at the column
- Continuous X-ray cassette tunnel from head to foot end
- Lateral guide rails for attachment of accessories, stainless steel, 25 x 10 mm
- Viscoelastic SF (H = 80 mm) or PUR upholstery (H = 60 mm), electrically conductive, detachable, radiolucent
- Four double swivel casters \varnothing 125 mm, electrically conductive, two castors with directional stability, lockable by means of central brake via foot pedal
- Power supply 110 V or 220 V, 50-60 Hz, integrated batteries incl. charger

Further electric models with standard height:

Art.-no. 504325

Additionally with longitudinal sliding up to 285mm

Art.-no. 504220

With gas spring supported back rest adjustment

Configuration example

Art.-no. 504325

Electric operating table

Art.-no. 61144SF

Head rest

Art.-no. 61655SF

Kidney elevator

Art.-no. 61615SF

Divided leg rests

Art.-no. 61220SF

Arm rest

Price on request!

Specialities

- Day surgery
- General surgery
- Gynaecology
- Urology
- Proctology

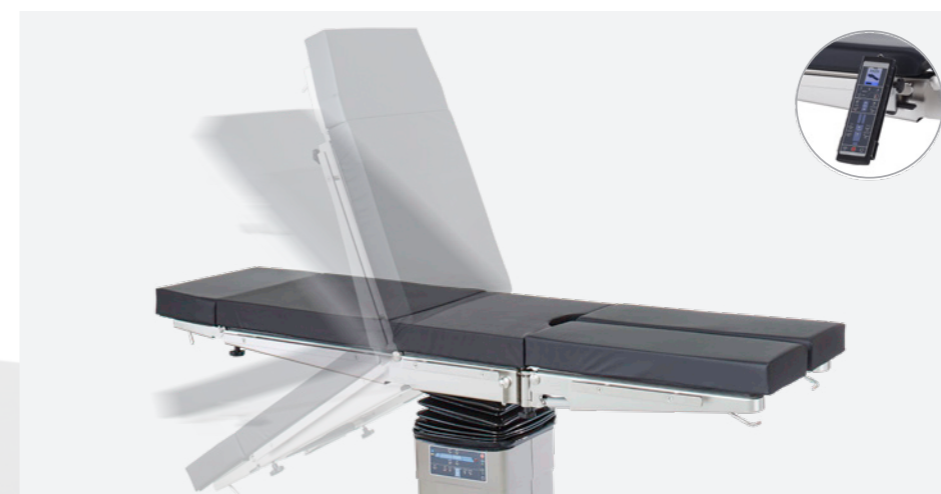

- Available with manual or electrical adjustment of back rest
- Overview of all configuration options on page 16-17

medifa 5000 electric

with low height



Electric operating table

Art.-no 505320

- Electrical height adjustment from 600 up to 950 mm
- Electrical Trendelenburg adjustment from -30° up to +25°
- Electrical lateral tilt up to 20°
- Electrical adjustment of back rest from -40° up to +70°
- Adjustment to flex/ reflex position
- Return to 0-position
- Corded hand switch with integrated colour display and battery indicator for electrical functions
- Additional control unit at the column
- Continuous X-ray cassette tunnel from head to foot end
- Lateral guide rails for attachment of accessories, stainless steel, 25 x 10 mm
- Viscoelastic SF (H = 80 mm) or PUR upholstery (H = 60 mm), electrically conductive, detachable, radiolucent
- Four double swivel casters \varnothing 125 mm, electrically conductive, two castors with directional stability, lockable by means of central brake via foot pedal
- Power supply 110 V or 220 V, 50-60 Hz, integrated batteries incl. charger

Further electric models with standard height:

Art.-no. 505325

Additionally with longitudinal sliding up to 285mm

Art.-no. 505220

With gas spring supported back rest adjustment

Configuration example

Art.-no. 505325

Electric operating table

Art.-no. 61144SF

Head rest

Art.-no. 61655SF

Kidney elevator

Art.-no. 61615SF

Divided leg rests

Art.-no. 61220SF

Arm rest

Price on request!

Specialities



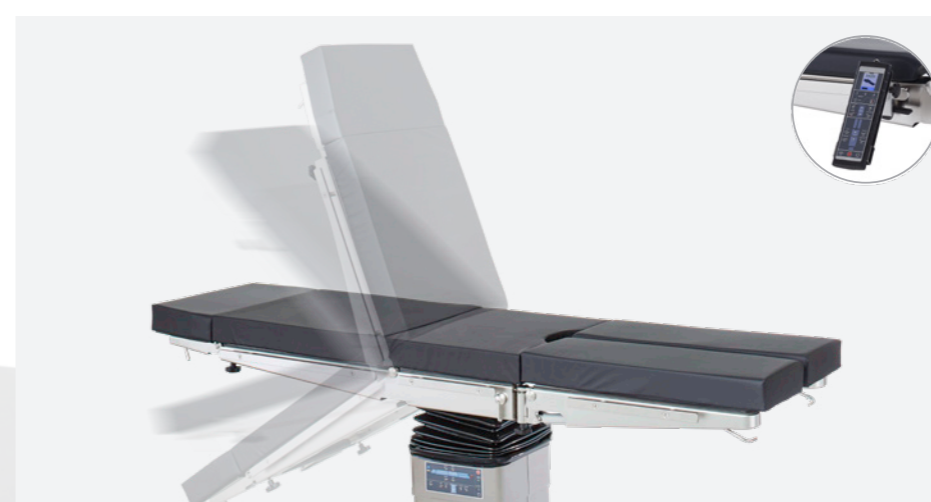















- Day surgery
- General surgery
- Gynaecology
- Urology
- Proctology



- Available with manual or electrical adjustment of back rest
- Overview of all configuration options on page 16-17

Models at a glance

● Electrical ■ Manual ◆ Optional

		Manuell	
			
	Adjusting range	501130	501135
	Height adjustment	750 - 1000 mm	750 - 1000 mm
	Height adjustment	780 - 1080 mm	780 - 1080 mm
	Height adjustment	600 - 950 mm	600 - 950 mm
	Trendelenburg	-30° / +30°	-30° / +30°
	Trendelenburg	-30° / +25°	-30° / +25°
	Lateral tilt	-20° / +20°	-20° / +20°
	Back rest adjustment	-40° / +70°	-40° / +70°
	Back rest adjustment	-40° / +75°	-40° / +75°
	Longitudinal sliding	310 mm	310 mm
	Longitudinal sliding	285 mm	285 mm
	Automatic leveling		
	Flexion		
	Central brake		
	Kidney bridge		
	Memory (3 Positions)		
	Max. permissible overall load	250 kg	250 kg

Electrical			Electrical with low height		
					
504220	504320	504325	505220	505320	505325
●	●	●	●	●	●
●	●	●	●	●	●
●	●	●	●	●	●
●	●	●	●	●	●
●	●	●	●	●	●
■	●	●	■	●	●
●	●	●	●	●	●
●	●	●	●	●	●
■	■	■	■	■	■
◆	◆	◆	◆	◆	◆
●	●	●	●	●	●
250 kg	250 kg	250 kg	250 kg	250 kg	250 kg

Positioning examples



General surgery in supine position



Thoracic surgery in lateral position



Gynaecology, urology and proctology in lithotomy position



Knee arthroscopy in supine position



Shoulder arthroscopy in beach chair position

Technical data

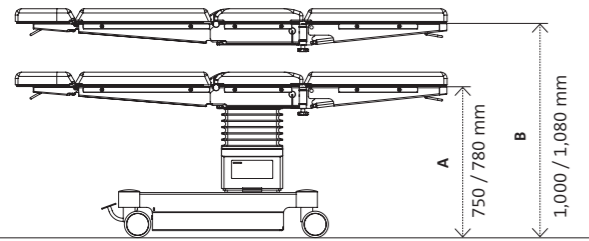

Models	Adjusting range	
	Height A	Height B
501130 / 501135	750 mm	1,000 mm
504220 / 504320 / 504325	780 mm	1,080 mm

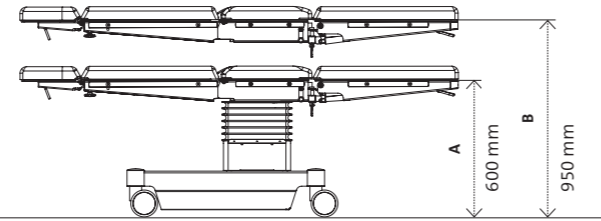

Models	Adjusting range	
	Height A	Height B
505220 / 505225 / 505320 / 505325	600 mm	950 mm

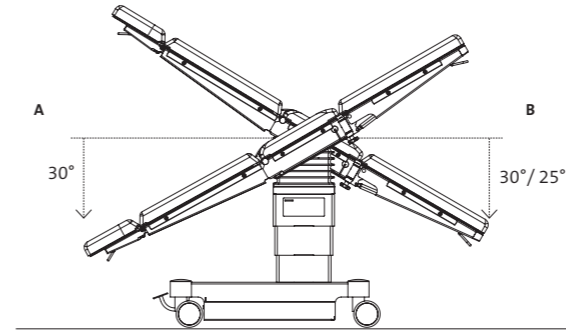

Models	Adjusting range	
	A	B
501130 / 501135	30°	30°
504220 / 504320 / 504325	30°	25°
505220 / 505320 / 505325	30°	25°

Lengths with SF upholstery

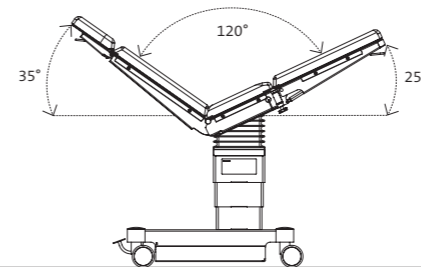
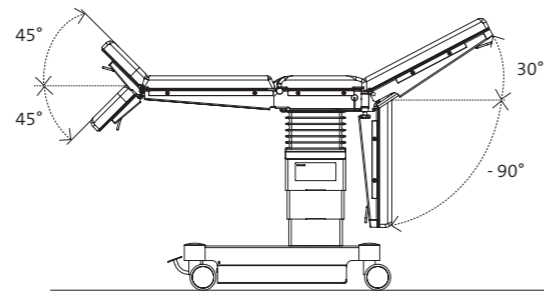
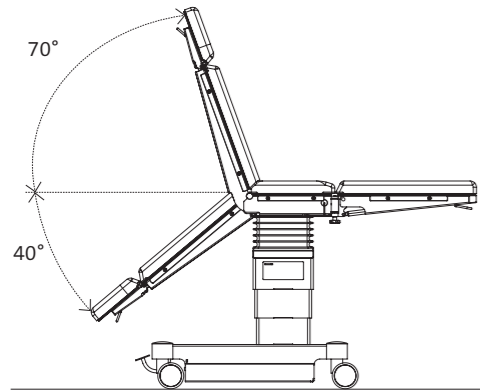
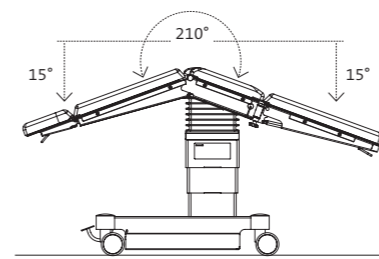
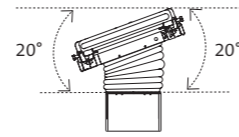
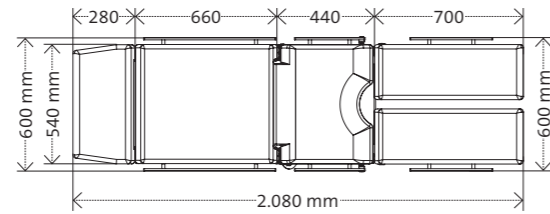
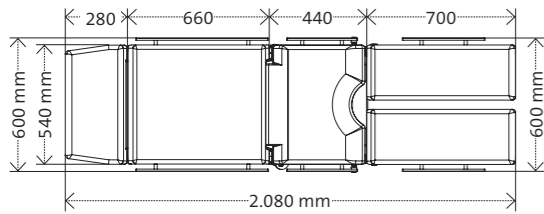

Models	Intraoperative imaging
501135	██████████
504325	██████████
505325	██████████

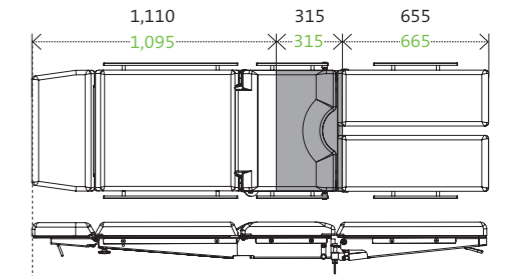

Sliding of table top left-sided

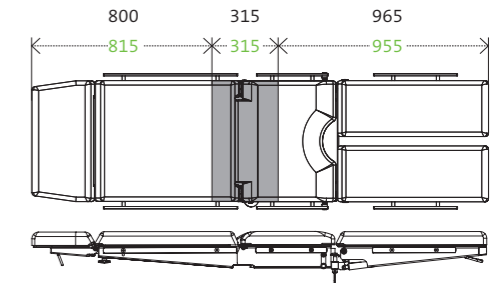

Sliding of table top right-sided

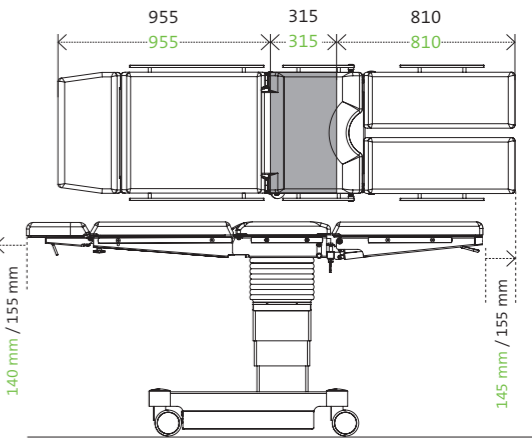

Basic position

Technical data is subject to a general industry tolerance of ± 3 %.

Configuration

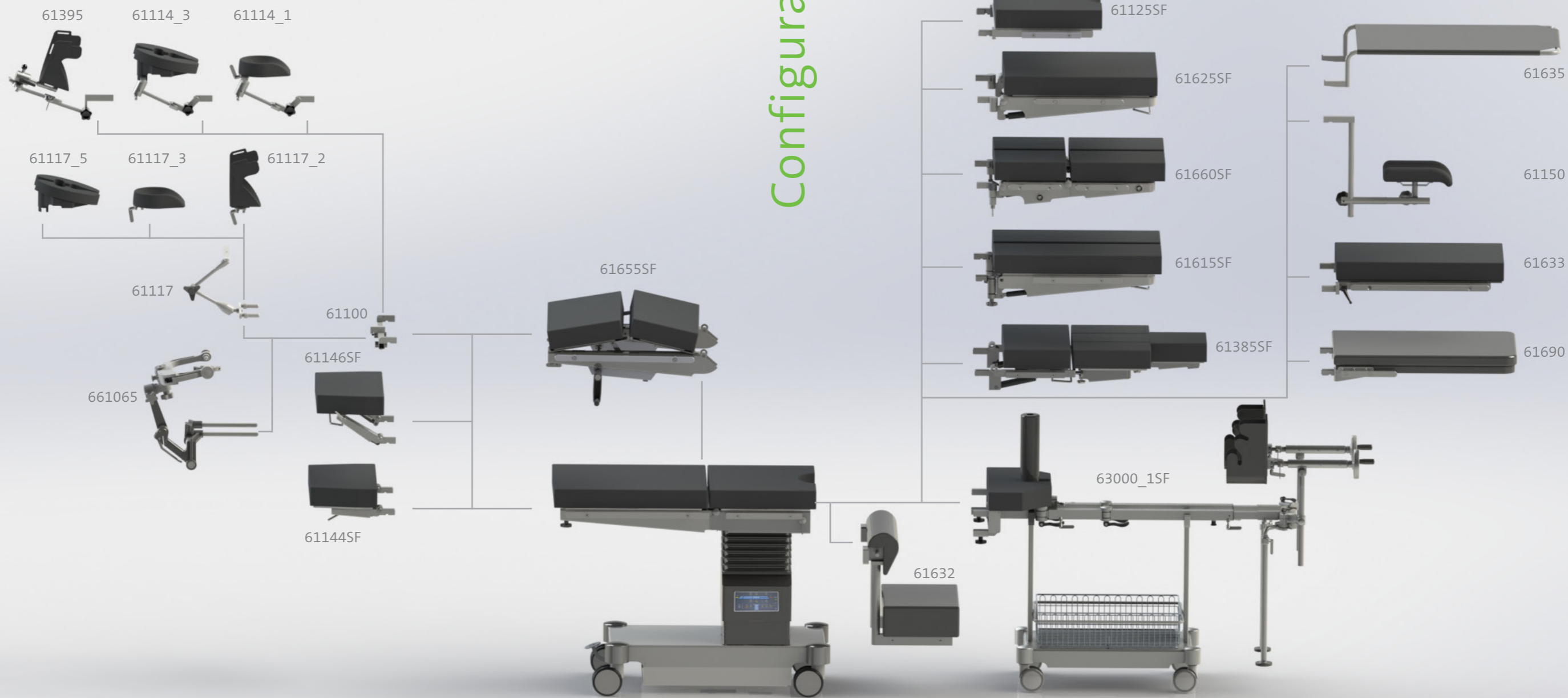

Accessories for medifa 5000



Foot switch for medifa 5000 & 6000

Art.-no. 604060

- Additional control unit to adjust the main functions height, lateral and Trendelenburg movement
- Tethered
- Cannot be retrofitted!



Infrared remote control for medifa 5000 & 6000

Art.-no. 604070

- Wireless data transfer
- Control panel for all electric functions of operating table
- Incl. charging station



X-ray capable connecting bar for medifa 5000 & 6000

Art.-no. 61670

- Exchange of stainless steel connecting bar at back rest with a radiolucent connecting bar made of special plastic
- Improves radiolucency of back rest



Kidney bridge for medifa 5000 & model 601120

Art.-no. 61655SF

- Manually adjustable by hand crank
- Upholstery: Viscoelastic SF upholstery, H = 80 mm, radiolucent, electrically conductive, detachable
- Also available with PUR upholstery, H = 60 mm (Art.-no. 61655)
- Cannot be retrofitted!



Head rest large for medifa 5000 & 6000

Art.-no. 61144SF

- Easy adjustment by means of gas spring from -45° to +45°
- Docking and undocking at back rest
- L x W: 285 x 495 mm
- Upholstery: Viscoelastic SF upholstery, H = 80 mm, radiolucent, electrically conductive, detachable
- Also available with PUR upholstery, H = 60 mm (Art.-no. 61144)



Head rest large with double joint for medifa 5000 & 6000

Art.-no. 61146SF

- Easy adjustment by means of gas spring from -45° to +45°
- Double joint enables additional tilting
- Docking and undocking at back rest
- L x W: 285 x 495 mm
- Upholstery: Viscoelastic SF upholstery, H = 80 mm, radiolucent, electrically conductive, detachable
- Also available with PUR upholstery, H = 60 mm (Art.-no. 61146)

Accessories for medifa 5000



Tripartite back rest for medifa 5000 & model 601120

Art.-no. 61385SF

- Incl. head rest
- Easy access to shoulder area by means of three detachable segments
- Docking and undocking at pelvis section (Reverse-Mode)
- Easy adjustment by means of gas spring
- L x W: each segment 315 x 170 mm
- Upholstery: Viscoelastic SF upholstery, H = 80 mm, radiolucent, electrically conductive, detachable
- Also available with PUR upholstery, H = 60 mm (Art.-no. 61385)

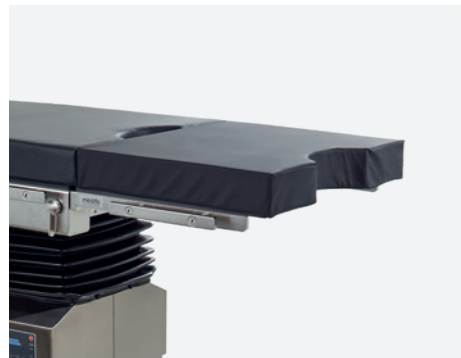

Pelvis section extension for medifa 5000 & 6000 (L= 430 mm)

Art.-no. 61125SF

- Extension of pelvis section by 430 mm
- With cut-out
- Integrated side rails (EU)
- L x W: 430 x 540 mm
- Upholstery: Viscoelastic SF upholstery, H = 80 mm, radiolucent, electrically conductive, detachable
- Also available with PUR upholstery, H = 60 mm (Art.-no. 61125)

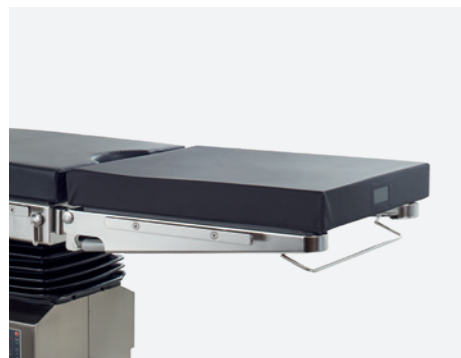

Leg rest for medifa 5000 & models 601120, 601700, 601820

Art.-no. 61625SF

- Adjustment by means of gas spring from -90° up to +30°
- Docking and undocking at pelvis section
- Integrated side rails (EU)
- L x W: 670 x 540 mm
- Upholstery: Viscoelastic SF upholstery, H = 80 mm, radiolucent, electrically conductive, detachable
- Also available with PUR upholstery, H = 60 mm (Art.-no. 61625)



Divided leg rest for medifa 5000 & models 601120, 601700, 601820 (pair)

Art.-no. 61615SF

- Adjustment by means of gas spring from -90° up to +30°, swivelling up to 180°
- Docking and undocking at pelvis section
- Integrated side rails (EU)
- L x W: each 730 x 250 mm
- Upholstery: Viscoelastic SF upholstery, H = 80 mm, radiolucent, electrically conductive, detachable
- Also available with PUR upholstery, H = 60 mm (Art.-no. 61615)

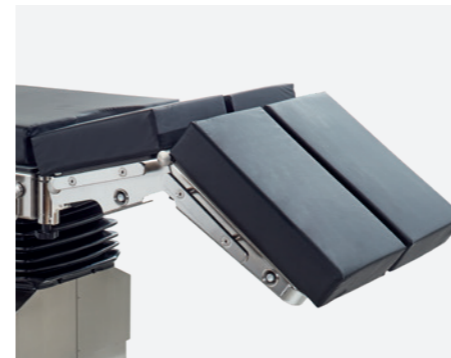

Double divided leg rest for medifa 5000 & models 601120, 601700, 601820 (pair)

Art.-no. 61660SF

- Adjustment by means of gas spring from +30° up to -90°, swivelling up to 180°, bendable
- Docking and undocking at pelvis section
- Integrated side rails (EU)
- L x W: each 720 x 250 mm
- Upholstery: Viscoelastic SF upholstery, H = 80 mm, radiolucent, electrically conductive, detachable
- Also available with PUR upholstery, H = 60 mm (Art.-no. 61660)



Carbon positioning rest for medifa 5000 & 6000

Art.-no. 61690

- Incl. upholstery
- For intraoperative x-ray, optimal radiolucency (360°)
- Docking and undocking at pelvis section or lower back rest
- L x W: 750 x 540 mm
- Upholstery: SF, H = 45 mm, radiolucent, electrically conductive

Accessories for medifa 5000

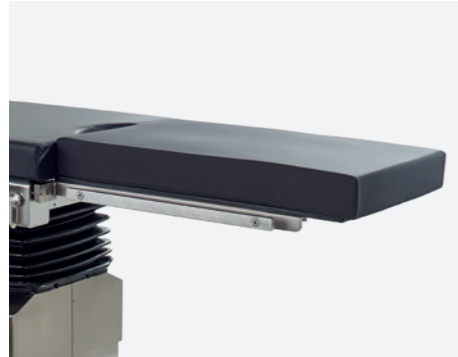

Paediatric surgery rest for medifa 5000 & 6000

Art.-no. 61633

- Docking and undocking at pelvis section
- Integrated side rails (EU)
- L x W: 700 x 430 mm
- Upholstery: Viscoelastic foam, H = 60 mm, electrically conductive



Transfer leg rest for medifa 5000 & 6000

Art.-no. 61635

- For short-time positioning of legs
- Docking and undocking at pelvis section
- L x W: 900 x 500 mm

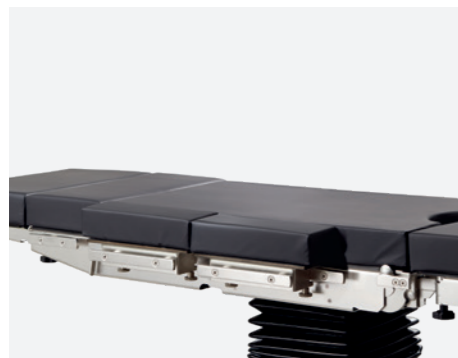

Extension segments medifa 5000, 6000 & 7000 (pair)

Art.-no. 61355SF

- Segments for extension of operating table's lying surface
- Integrated side rails (EU)
- L x W: each segment 310 x 110 mm
- Upholstery: Viscoelastic SF upholstery, H = 70 mm, radiolucent, electrically conductive, detachable
- Also available with PUR upholstery, H = 60 mm (Art.-no. 61355)



Rinsing set for medifa 5000 & 6000

Art.-no. 61120

- Incl. bucket, basin, strainer, tube, undercarriage and fixation
- Docking and undocking at pelvis section
- L x W x H (Basin): 325 x 265 x 65 mm
- Volume (Bucket): 15 litre
- Material: Stainless steel

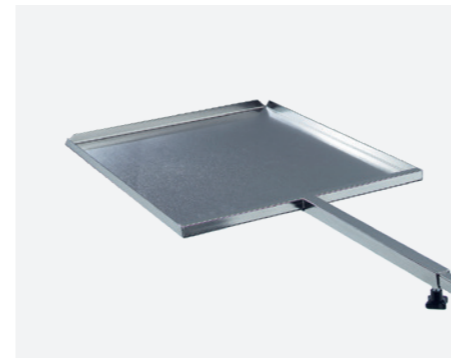

Radiographic cassette carrier for medifa 5000 & 6000

Art.-no. 61640

- To insert radiographic cassettes under table top of operating table
- With telescopic rod
- L x W x H: 470 x 385 x 16 mm
- Suitable for radiographic cassettes with dimensions 14" x 17" (US)
- Material: Stainless steel



Transport box for medifa 5000 BASIC

Art.-no. 61095

- For safe transport of operating table
- L x W x H: 1200 x 800 x 952 mm
- Material: Aluminium

Available upon request!

Additional accessories

A wide range of optional accessories complements the application spectrum of our operating tables.

For central storage of accessories we offer a trolley (art.-no. 341045) made of polished stainless steel.

Further accessories can be found in our brochure "Accessories for operating tables".



medifa

Competence around operating rooms

As a leading international manufacturer of medical products, medifa GmbH offers innovative products and solutions for operating rooms, mobile hybrid operating systems and other areas in hospitals or outpatient surgical centers. The big product portfolio includes mobile operating tables and operating accessories, mobile carbon operating tables, operating lights, as well as examination and treatment chairs.

The medifa GmbH is a company of the Reinsberg Group, a leading and globally active European manufacturer of medical products and solutions for hospitals.

The development, construction and production of medifa products take place in Germany. With a large share of added value in the company group, medifa guarantees its customers fast response times and high quality "Made in Germany" in accordance with certified national and international quality standards. medifa consistently focuses on the current and future requirements of its customers. In line with the slogan "we care", customers from all over the world can rely on top-class consultation, processing and quality from a single source.

Products

- Operating lights (medifa H!Light)
- Mobile operating tables
- Mobile carbon operating tables for minimal invasive applications
- Accessories for operating tables and lights
- Examination and treatment chairs (gynecology, urology and proctology)
- Medical functional furniture

medifa worldwide

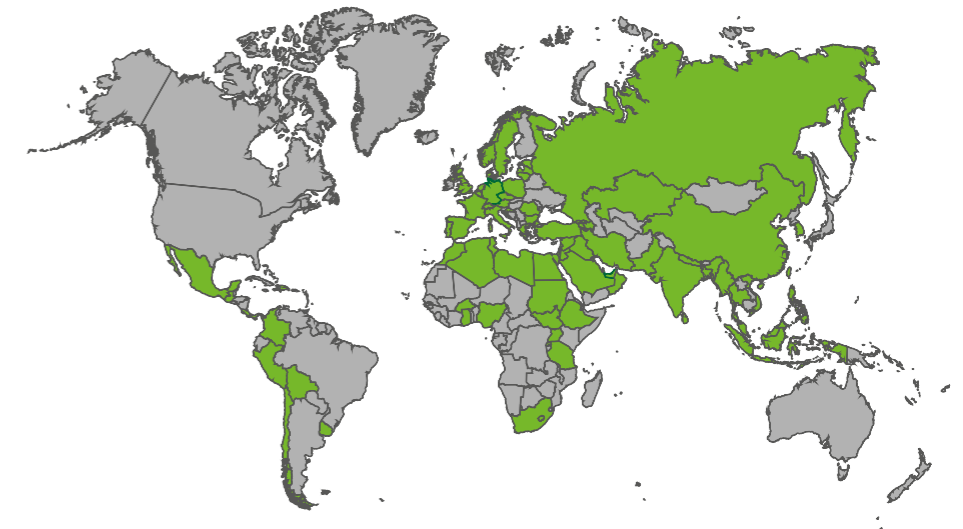

medifa

Member of REINSBERG® GROUP



medifa GmbH

Industriestraße 5

57413 Finnentrop

Germany

fon +49 2721 71 77 -0

fax +49 2721 71 77 -255

www.medifa.com

info@medifa.com

Version 01-24-EN

Subject to modifications due to technical development.

This document is intended to provide information to an international audience outside of the US.



Made in Germany

www.medifa.com

we care.