



## medifa 6000

Mobile  
Operating Tables



we care.

# medifa 6000

- Electro-hydraulic models
- Additional back-up system independent from any power supply (optional)
- Models with sliding table top
- Available with viscoelastic foam or PUR upholsteries
- All metal components made of high-quality stainless steel (1.4301)
- Optimal cleaning and disinfection conditions
- Simple manoeuvrability
- Smooth running release mechanisms
- User-friendly control concept
- Suitable for various applications and patient positionings
- Suitable for x-ray and c-arm applications
- Wide range of accessories for all surgical disciplines
- Maximum permissible overall load of 454 kg



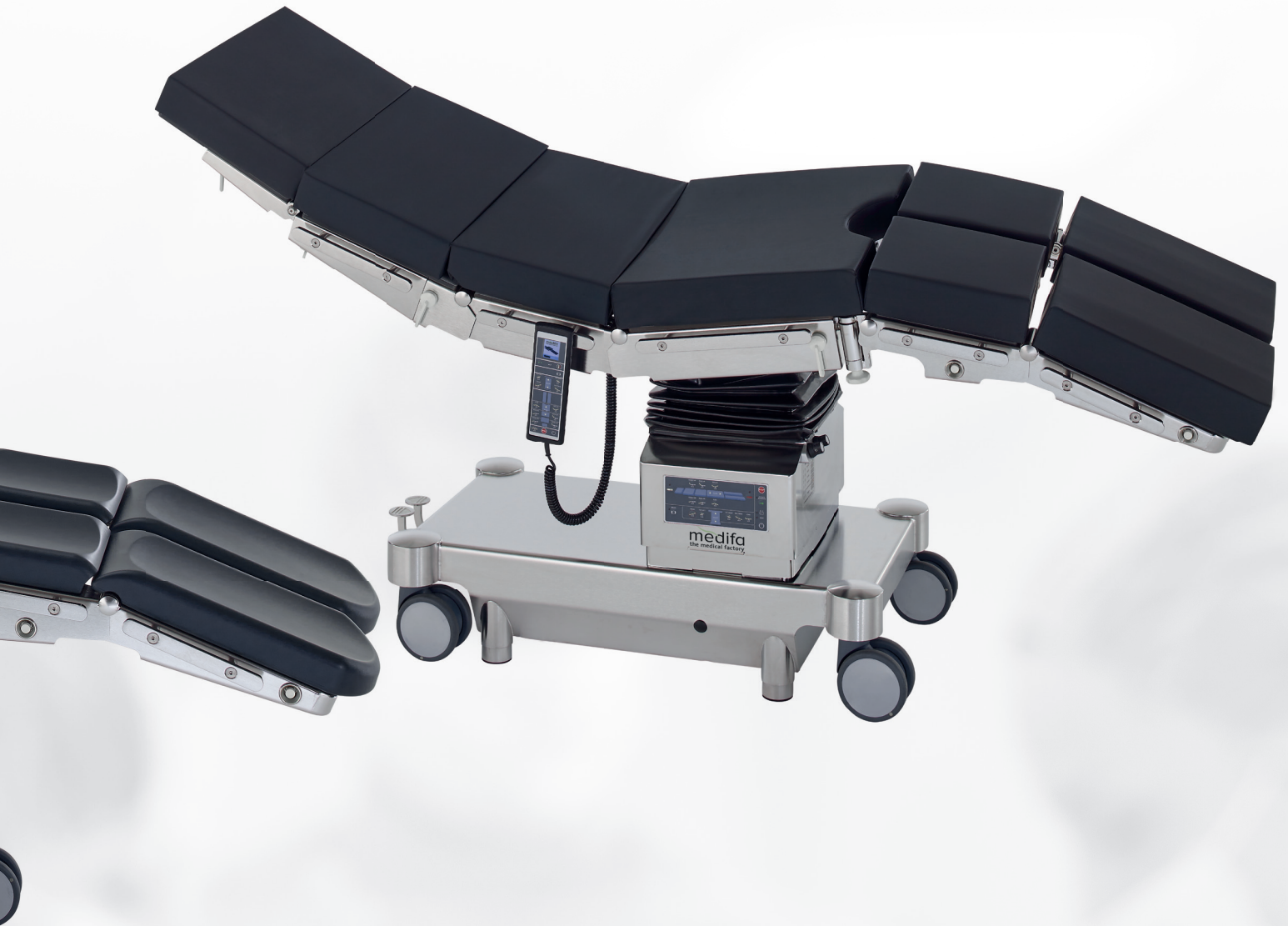

# medifa 6000



## Electro-hydraulic operating table

### Art.-no. 601700

- Height adjustment from 690 mm to 1050 mm
- Trendelenburg adjustment from  $-30^{\circ}$  up to  $+30^{\circ}$
- Lateral tilt up to  $20^{\circ}$
- Lower back rest adjustment from  $-40^{\circ}$  up to  $+70^{\circ}$
- Upper back rest adjustment from  $-35^{\circ}$  up to  $+50^{\circ}$
- Flex / Reflex position
- Return to 0-position
- Selection of patient orientation (reverse mode)
- Lateral guide rails for attachment of accessories, stainless steel, 25 x 10 mm
- Continuous X-ray tunnel from head- to foot end
- Mobility with central brake
- Fifth castor
- PUR upholsteries (H = 60 mm) or optionally viscoelastic foam upholsteries (H = 80 mm), electrically conductive, detachable
- Maximum permissible overall load: 454 kg (1,000 lbs)

## Further models:

### Art.-no. 601820

Additionally with longitudinal sliding up to 300 mm

### Art.-no. 601120

With one-piece back rest, additionally with longitudinal sliding up to 300 mm

### Configuration example

**Art.-no. 601700**  
Electro-hydraulic  
operating table

**Art.-no. 61144**  
Head rest

**Art.-no. 61250**  
Upper back rest

**Art.-no. 61615**  
Divided leg rests

**Art.-no. 61220**  
Arm rest

**Price on request!**

### Specialities

- General surgery
- Orthopaedics
- Gynaecology
- Urology
- ENT



- Model art.-no. 601120 can be equipped with an optional manual kidney bridge
- All models of medifa 6000 can be equipped with a wide range of further accessories!

# Control concept



Colour display with battery indicator

Navigation and acknowledgement keys

Reverse-Mode

Central brake

Positioning keys

Activation of hand switch

Stop-Key

Leveling

1. Standard: Backlit hand switch with integrated colour display and battery indicator (optional: wireless infrared remote control, art.-no. 604070, not retrofittable)
2. Standard: Additional control unit at the column
3. Optional: Foot switch for height, lateral and Trendelenburg adjustment (art.-no. 604060)
4. Optional: Manual back-up system operated by foot pedal releases (art.-no. 50655, not retrofittable)



# Functionality and Comfort



- Quick and simple handling
- Smooth running release mechanisms



- Easy maneuverability by means of double swivel castors and fifth castor
- Excellent foot access for the surgeon

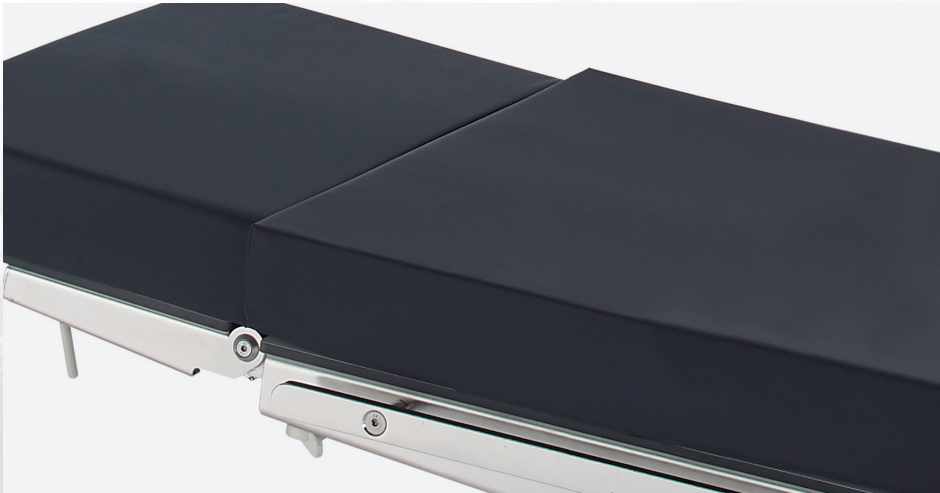













- Multilayer viscoelastic foam upholsteries
- Height: 80 mm
- Detachable
- Electrically conductive



- Ergonomically formed PUR upholsteries
- Height: 60 mm
- Detachable
- Electrically conductive

# Models



	Adjusting range	601120	601700	601820
 Height adjustment	690 - 1050 mm	●	●	●
 Trendelenburg	-30° / +30°	●	●	●
 Lateral tilt	-20° / +20°	●	●	●
 Back rest adjustment (lower back rest)	-40° / +70°	●	●	●
 Back rest adjustment (upper back rest)	-35° / +50°		●	●
 Flexion movement		●	●	●
 Longitudinal sliding	300 mm	●		●
 Fifth castor		●	■	■
 Automatic levelling		●	●	●
 Central brake		●	●	●
 Kidney bridge		◆	●	●
 Manual override		◆	◆	◆
 Stability cylinders at the base		◆	◆	◆
 Maximum permissible overall load		454 kg	454 kg	454 kg

● Electro-hydraulic    ■ Manual    ◆ Optional

# Positionings



Reverse position with longitudinal sliding



Flex position for kidney and thorax interventions



Positioning with kidney elevator for gall bladder interventions



Beach-Chair-Position for struma interventions

# Positionings



Lithotomy position with leg rests for gynaecological interventions



Lithotomy position with leg rests and drainage for urological interventions



Positioning with knee rests and pressure relief cushion for proctological interventions



Back position with horseshoe shaped head rest for neurological interventions



Positioning with skull clamp system for neurological interventions



Positioning with lower leg extension for interventions of tibial fractures



Positioning with extension device for interventions of femoral fractures



Positioning with arm rest and arm extension for interventions of arm fractures

# Technical information

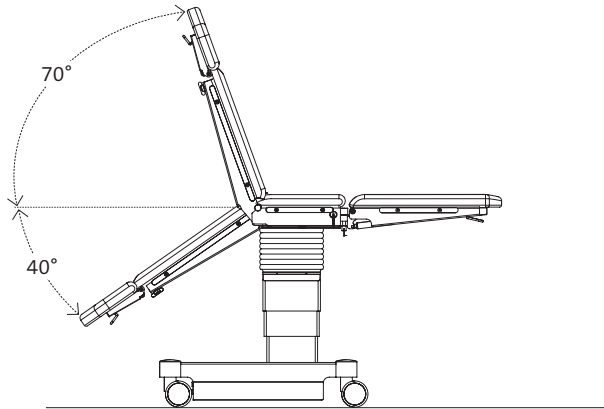
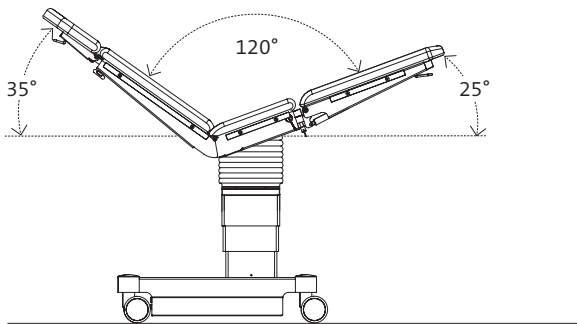
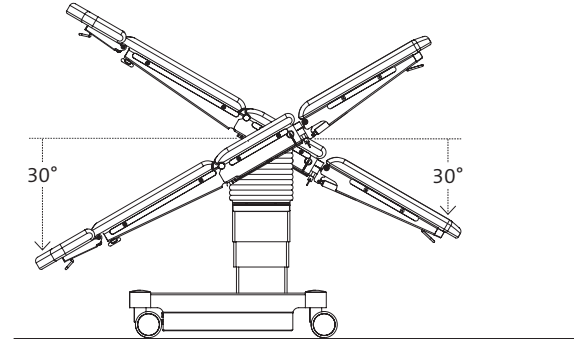
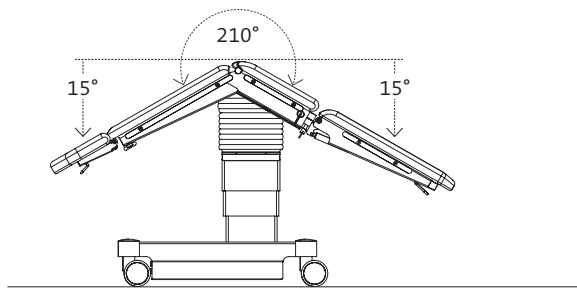
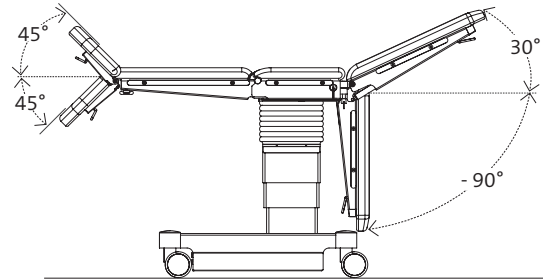
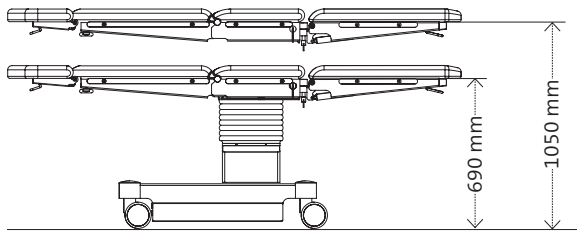

Only models 601700 / 601820

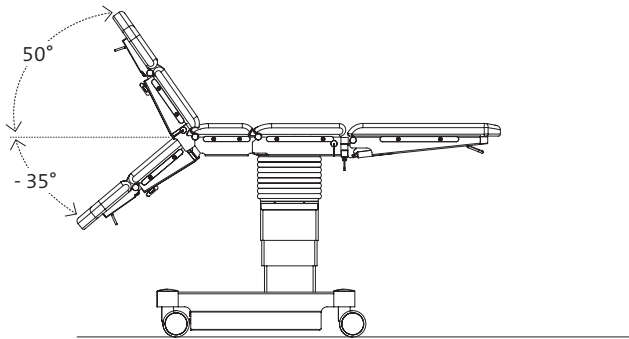
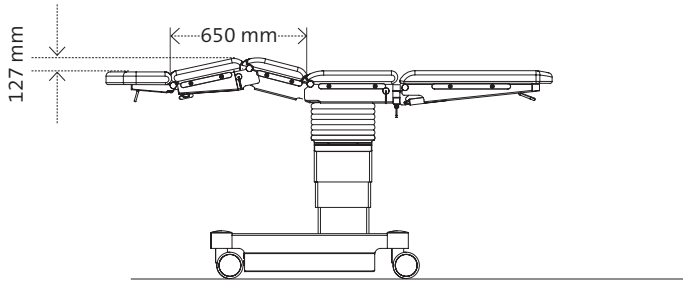

Sliding table top  
(only models 601120 and 601820)

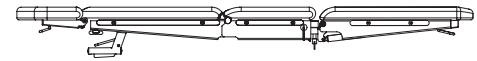
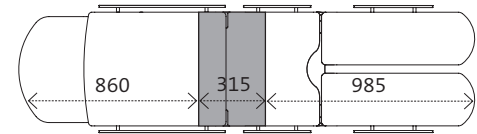
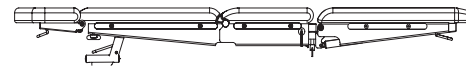
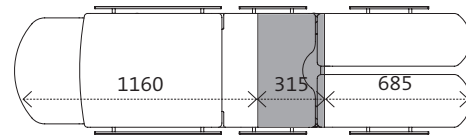

Ground plan 601120

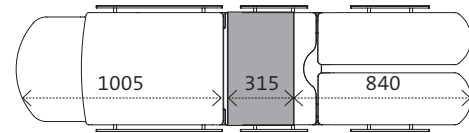
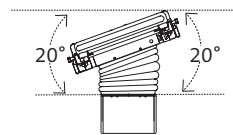
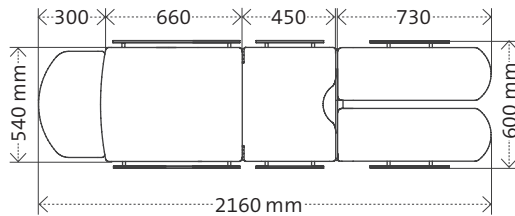

Ground plan 601700 / 601820

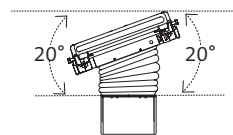
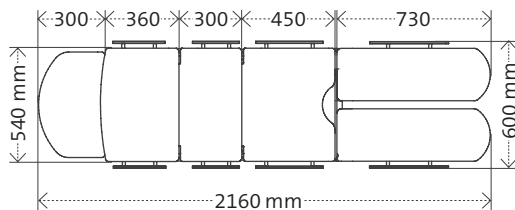



# Configuration



# Accessories for medifa 6000



## Head rest large for medifa 5000 and 6000

### Art.-no. 61144

- Easy adjustment by means of gas spring from  $-45^{\circ}$  to  $+45^{\circ}$
- Docking and undocking at back rest
- L x W: 285 x 495 mm
- Upholstery: PUR, H = 60 mm, radiolucent, electrically conductive
- Also available with viscoelastic foam upholstery, H= 80 mm (Art.-no. 61144SF)



## Head rest large with double joint for medifa 5000 and 6000

### Art.-no. 61146

- Easy adjustment by means of gas spring from  $-45^{\circ}$  to  $+45^{\circ}$
- Double joint enables additional tilting
- Docking and undocking at back rest
- L x W: 285 x 495 mm
- Upholstery: PUR, H = 60 mm, radiolucent, electrically conductive
- Also available with viscoelastic foam upholstery, H= 80 mm (Art.-no. 61146SF)



## Upper back rest for models 601700 and 601820

### Art.-no. 61250

- Docking and undocking at lower back rest
- Integrated side rails (EU)
- L x W: 360 x 540 mm
- Upholstery: PUR, H = 60 mm, radiolucent, electrically conductive
- Also available with viscoelastic foam upholstery, H= 80 mm (Art.-no. 61250SF)



### **Kidney bridge for medifa 5000 and model 601120**

#### **Art.-no. 61655**

- Manually adjustable by hand crank
- Upholstery: PUR, H = 60 mm, radiolucent, electrically conductive
- Cannot be retrofitted!



### **Tripartite back rest for medifa 5000 and model 601120**

#### **Art.-no. 61385**

- Incl. head rest
- Easy access to shoulder area by means of three detachable segments
- Docking and undocking at pelvis section (Reverse-Mode)
- Easy adjustment by means of gas spring
- L x W: each segment 315 x 170 mm
- Upholstery: PUR, H = 60 mm, radiolucent, electrically conductive
- Also available with viscoelastic foam upholstery, H= 80 mm (Art.-no. 61385SF)



### **Tripartite back rest for models 601700 and 601820**

#### **Art.-no. 61390**

- Incl. head rest
- Easy access to shoulder area by means of three detachable segments
- Docking and undocking at lower back rest
- L x W: each segment 315 x 170 mm
- Upholstery: PUR, H = 60 mm, radiolucent, electrically conductive
- Also available with viscoelastic foam upholsteries, H= 80 mm (Art.-no. 61390SF)

# Accessories for medifa 6000



## Pelvis section extension for medifa 5000 and 6000

### Art.-no. 61125

- Extension of pelvis section by 430 mm
- With cut-out
- Integrated side rails (EU)
- L x W: 430 x 540 mm
- Upholstery: PUR, H = 60 mm, radiolucent, electrically conductive
- Also available with viscoelastic foam upholstery, H= 80 mm (Art.-no. 61125SF)



## Leg rest for medifa 5000 and 6000

### Art.-no. 61625

- Adjustment by means of gas spring from +30° up to -90°
- Docking and undocking at pelvis section
- Integrated side rails (EU)
- L x W: 670 x 540 mm
- Upholstery: PUR, H = 60 mm, radiolucent, electrically conductive
- Also available with viscoelastic foam upholstery, H= 80 mm (Art.-no. 61625SF)



## Divided leg rest for medifa 5000 and 6000

### Art.-no. 61615

- Adjustment by means of gas spring from +30° up to -90°, swivelling up to 180°
- Docking and undocking at pelvis section
- Integrated side rails (EU)
- L x W: each 730 x 250 mm
- Upholstery: PUR, H = 60 mm, radiolucent, electrically conductive
- Also available with viscoelastic foam upholstery, H= 80 mm (Art.-no. 61615SF)
- Pair



#### **Double divided leg rest for medifa 5000 and 6000**

##### **Art.-no. 61660**

- Adjustment by means of gas spring from +30° up to -90°, swivelling up to 180°, bendable
- Docking and undocking at pelvis section
- Integrated side rails (EU)
- L x W: each 720 x 250 mm
- Upholstery: PUR, H = 60 mm, radiolucent, electrically conductive
- Also available with viscoelastic foam upholstery, H= 80 mm (Art.-no. 61660SF)
- Pair



#### **Carbon positioning rest for medifa 5000 and 6000**

##### **Art.-no. 61690**

- Incl. upholstery
- For intraoperative x-ray, optimal radiolucency (360°)
- Docking and undocking at pelvis section or lower back rest
- L x W: 750 x 540 mm
- Upholstery: PUR, H = 45 mm, radiolucent, electrically conductive



#### **Transfer leg rest for medifa 5000 and 6000**

##### **Art.-no. 61635**

- For short-time positioning of legs
- Docking and undocking at pelvis section
- L x W: 900 x 500 mm

# Accessories for medifa 6000



## Paediatric surgery rest for medifa 5000 and 6000

**Art.-no. 61633**

- Docking and undocking at pelvis section
- Integrated side rails (EU)
- L x W: 700 x 430 mm
- Upholstery: Viscoelastic foam, H = 60 mm, electrically conductive



## Extension segments for medifa 5000 and 6000

**Art.-no. 61355**

- Segments for extension of operating table's lying surface
- Integrated side rails (EU)
- L x W: each segment 310 x 105 mm
- Upholstery: PUR, H = 60 mm, radiolucent, electrically conductive
- Also available with viscoelastic foam upholsteries, H= 80 mm (Art.-no. 61355SF)
- Pair



## Foot switch for medifa 5000 and medifa 6000

**Art.-no. 604060**

- Additional control unit to adjust the main functions height, lateral and Trendelenburg movement
- Tethered
- Cannot be retrofitted!



### Infrared remote control for medifa 5000 and medifa 6000

Art.-no. 604070

- Wireless data transfer
- Control panel for all electric functions of operating table
- Incl. charging station



### Manual back-up system for medifa 6000

Art.-no. 50655

- Secures the functionality of operating table in case of an electronic defect or breakdown of power supply
- Override of electronic functions by means of manual foot pedal
- Cannot be retrofitted!



### Stabilization cylinder for medifa 6000

Art.-no. 50650

- Extendible
- For optimal stability of operating table
- Cannot be retrofitted!



# Accessories for medifa 6000



## Connecting bar for medifa 5000 and 6000

**Art.-no. 61670**

- Exchange of stainless steel connecting bar at back rest with a radiolucent connecting bar made of special plastic
- Improves radiolucency of back rest

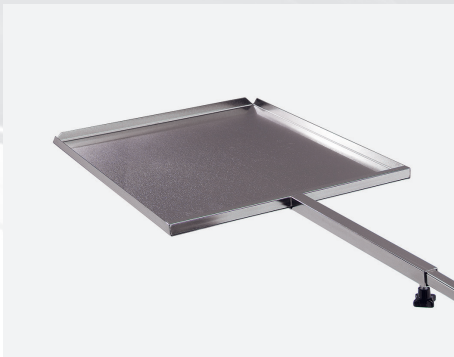

## Radiographic cassette carrier for medifa 5000 and 6000

**Art.-no. 61640**

- To insert radiographic cassettes under table top of operating table
- With telescopic rod
- L x W x H: 470 x 385 x 16 mm
- Suitable for radiographic cassettes with dimensions 14" x 17" (US)
- Material: Stainless steel



## Rinsing set for medifa 5000 and 6000

**Art.-no. 61120**

- Incl. bucket, basin, strainer, tube, undercarriage and fixation
- Docking and undocking at pelvis section
- L x W x H (Basin): 325 x 265 x 65 mm
- Volume (Bucket): 15 litre
- Material: Stainless steel

# Additional accessories

A wide range of optional accessories complements the application spectrum of our operating tables.

For central storage of accessories we offer a trolley (art.-no. 341045) made of polished stainless steel.

Further accessories can be found in our brochure "Accessories for operating tables".



# Further products for the OR

**medifa H!Light.** The operating light of medifa.

The LED operating lights from medifa ensure optimum working conditions for surgeons and nurses during the surgery.

The medifa H!Light has a universal handle holder. The use of a disposable handle, a sterile handle or a 4K wireless camera system on the same lamp head is possible without tools and future-proof. Sterile control of the main functions is available as an option.

Learn more:



## The medifa healthcare group unites competence concerning operating rooms under one roof.

medifa is an owner-run and internationally active complete solution provider in the medical technology.

The product and service portfolio covers all operating room requirements from modular wall, door, ceiling and cabinet systems (RooSy® Room Systems) for the turnkey operating room, as well as mobile operating tables, operating table accessories and operating lights, right up to examination chairs and medical

furniture. In addition, one of the largest German OEM suppliers in the medical technology sector also belongs to medifa.

medifa GmbH & Co. KG (Finnentrop), medifa hygienic rooms GmbH (Ötigheim) and medifa metall und medizintechnik GmbH in Rastatt are all part of this group of companies. The medifa healthcare group employs approximately 350 employees at three locations within Germany. The planning, engineering and production

take place exclusively in Germany, and with over 90% added value in the group of companies, the group guarantees fast reaction times.

The slogan “we care” means for us that we consistently orientate ourselves according to the requirements of our customers. Customers all over the world can rely on top-class consultation, processing and quality from a single source, made in Germany according to certified national and international quality standards.

## Products

- Modular operating room systems: walls, doors, ceilings and cabinets (RooSy)
- Mobile operating tables and accessories
- Operating lights
- Examination and treatment chairs
- Medical furniture and trolleys
- Customized medical solutions

## medifa worldwide

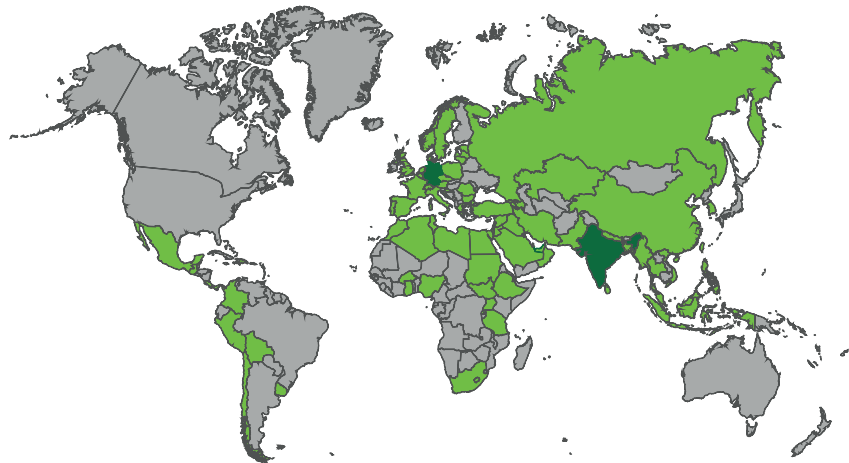

we care.



Version 02-19-EN  
Data subject to change without notice.

[www.medifa.com](http://www.medifa.com)

we care. Code



**medifa GmbH & Co. KG**

Industriestraße 5  
57413 Finnentrop  
Germany  
fon +49 2721 71 77 -0  
fax +49 2721 71 77 -255  
[info@medifa.com](mailto:info@medifa.com)

we care.